

---

# Controls and Instruments

---

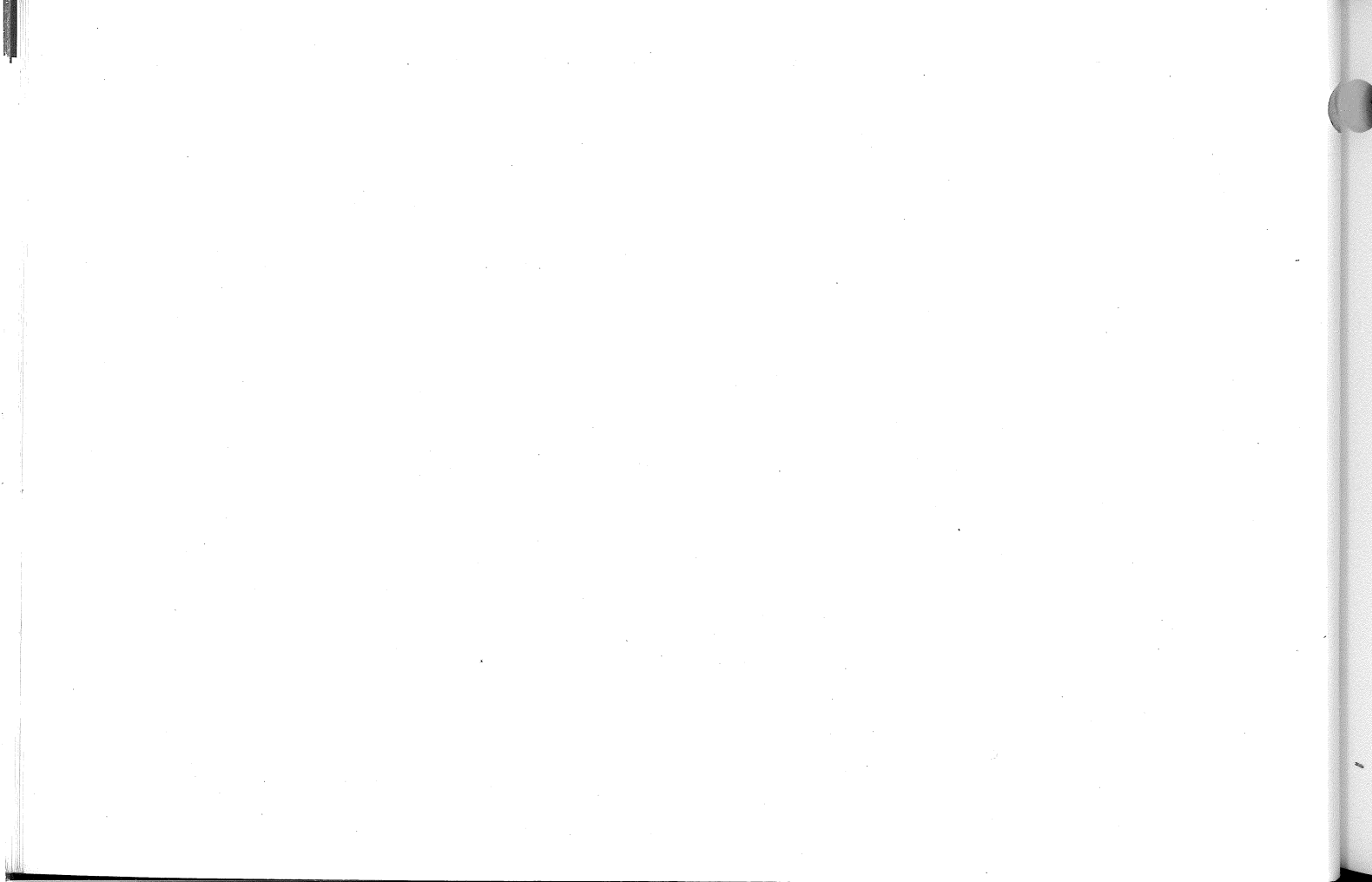

**Table of Contents**

Pedestal .....	6-5
Console .....	6-6
Circuit Breakers .....	6-8
Symbols for Controls and Instruments .....	6-9
Pedals and Dimmer Switch .....	6-11
Attachment Controls Switch Box .....	6-11
Switches and Warning Lights .....	6-11
Hand Brake Lever .....	6-12
Attachment Selector Valve .....	6-12
Air Cleaner Service Indicator .....	6-12
Windshield Release .....	6-12
Heater Vents .....	6-13
Heater Control Lever .....	6-13
Articulation Indicator .....	6-14
Hand Throttle .....	6-14
Battery Isolation Switch(es) .....	6-15
Hour Meter .....	6-15
Air Conditioner .....	6-16

**Table of Contents** continued

Fan Speed Control & Thermostat Control .....	6-16
Air Conditioner Operation and Radiator Shutters .....	6-17
Circle System Accumulators .....	6-18

## Pedestal

1. Left-hand Blade Lift Lever
2. Moldboard Slide Shift Lever
3. Moldboard Tilt Lever
4. Circle Turn Lever
5. Directional Indicator Switch
6. Hazard Lights (4-Way Flasher) Switch
7. Left-hand Directional Indicator Light
8. Left-hand Float Valve Switch
9. High Beam Indicator Light
10. Right-hand Float Valve Switch
11. Right-hand Directional Indicator Light
12. Tachometer
13. Hi-Lift Arm Lock Cylinder Lever
14. Circle Shift Lever
15. Scarifier/A-Frame Selector Valve Switch
16. Articulation Switch
17. Control Lever for Scarifier, Front-Mounted Blade or Plow
18. Right-hand Blade Lift Lever
19. Front Wheel Lean Lever
20. Steering Wheel
21. Pedestal Tilt Knob

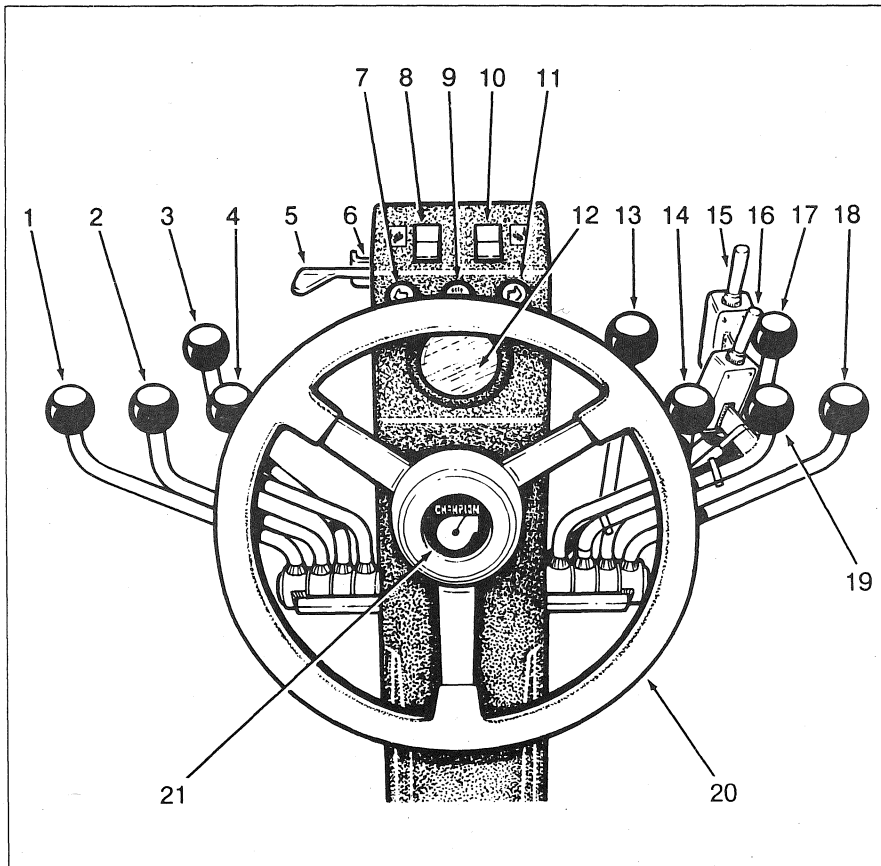

## Console

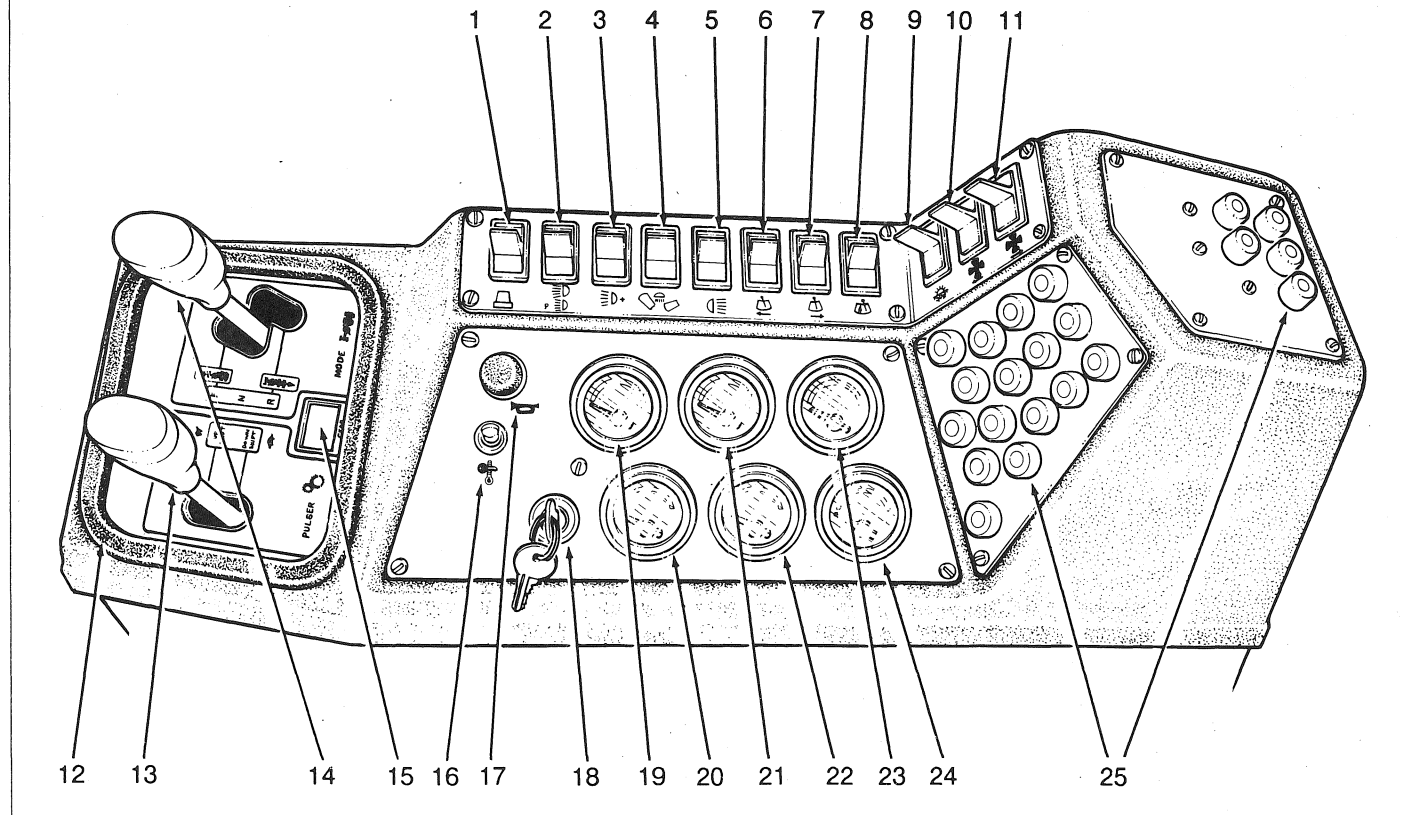

## Key to Console Items

1. Rotating Beacon Switch
2. Headlights and Parking Lights Switch
3. Extra Headlights Switch
4. Work Lights Switch
5. Rear Floodlights Switch
6. Front Windshield Wiper Switch
7. Rear Windshield Wiper Switch
8. Windshield Washer Switch
9. Heater Blower Switch
10. Front Defroster Fan Switch
11. Rear Defroster Fan Switch
12. Transmission Controller
13. Pulser Lever - Gear Selector
14. Mode Lever - Forward, Neutral or Reverse Selector
15. Digital Display
16. Cold Start Switch
17. Horn Button
18. Ignition Switch
19. Engine Temperature Gauge
20. Voltmeter
21. Engine Oil Pressure Gauge
22. Fuel Level
23. Transmission Oil Pressure Gauge
24. Transmission Oil Temperature Gauge
25. Circuit Breaker Panels

**Circuit Breakers:** If an electrical overload occurs, the circuit breaker is tripped and the button extends to the disengaged position. Press the button to reconnect the circuit. If the problem persists, have it repaired by a qualified service technician.

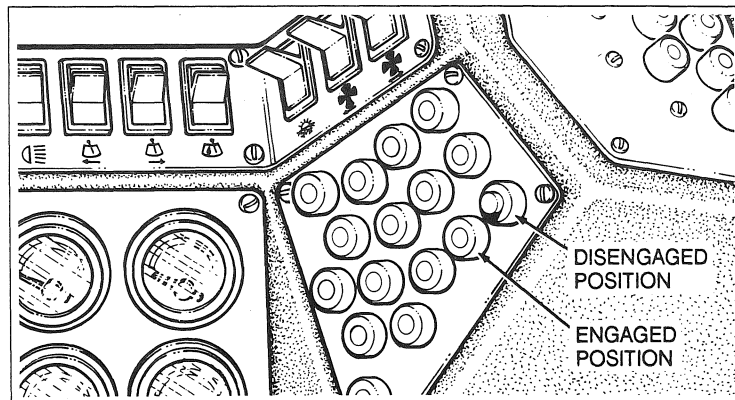







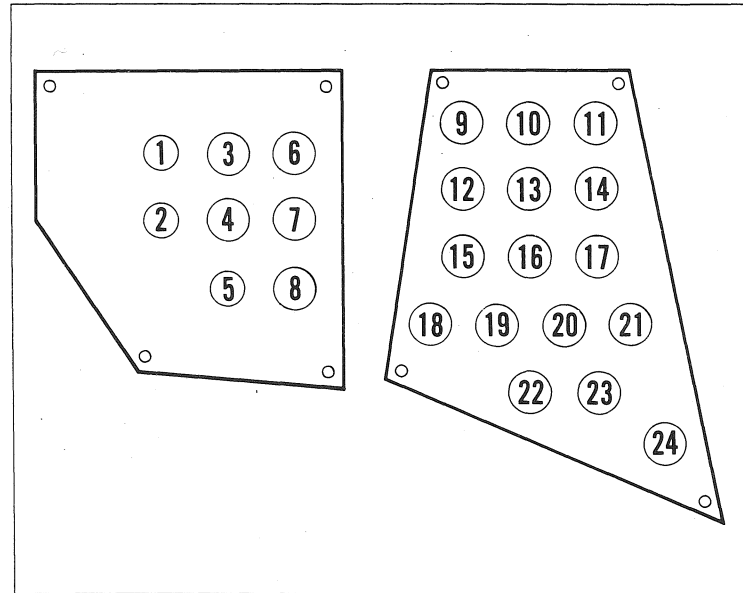



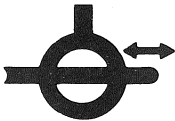





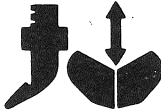

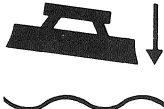
## Circuit Breakers

1. Headlights (Automatic Reset)
2. Air Conditioner (Automatic Reset)
3. Supplemental Steering
4. Tire Pump
5. Heater (Automatic Reset)
6. Back-up Lights and Alarm
7. Transmission Solenoid
8. Transmission Microprocessor
9. Cold Start
10. Wing or Rear-mounted Attachment Controls
11. Rotating Beacon
12. Rear Windshield Wiper
13. Front Windshield Wiper
14. Wing Lights
15. Windshield Washer
16. Extra Headlights
17. Rear Floodlights
18. Ignition Switch
19. Horn
20. Float Valves

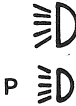









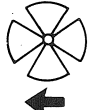
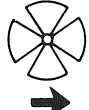

21. Defroster Fans
22. Pedestal Feed
23. Directional Indicators
24. Brake Lights and Dome Light



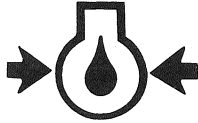

 <p>MOLDBOARD LIFT</p>	 <p>MOLDBOARD SLIDE SHIFT</p>	 <p>MOLDBOARD TILT</p>	 <p>CIRCLE TURN</p>	 <p>HI-LIFT ARM LOCK</p>
 <p>CIRCLE SHIFT</p>	 <p>FRONT WHEEL LEAN</p>	 <p>SCARIFIER, PLOW OR DOZER OPERATION</p>	 <p>LEFT-HAND MOLDBOARD FLOAT VALVE</p>	 <p>RIGHT-HAND MOLDBOARD FLOAT VALVE</p>
 <p>DIRECTIONAL INDICATORS</p>	 <p>HEADLIGHT HIGH BEAM</p>	 <p>ROTATING BEACON</p>	 <p>HEADLIGHTS/ PARKING LIGHTS</p>	 <p>EXTRA HEADLIGHTS</p>
 <p>WORK LIGHTS</p>	 <p>REAR FLOODLIGHTS</p>	 <p>FRONT WINDSHIELD WIPER</p>	 <p>REAR WINDSHIELD WIPER</p>	 <p>WINDSHIELD WASHER</p>

**Symbols for Controls and Instruments**

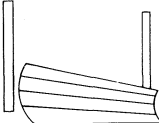
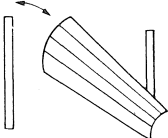
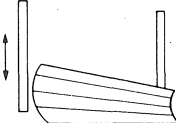
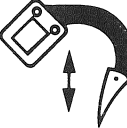
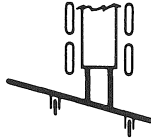

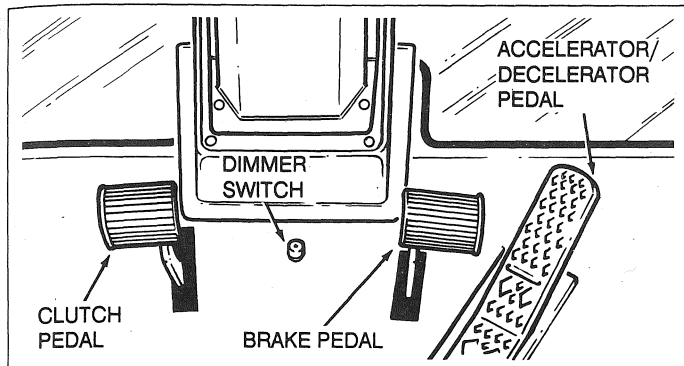



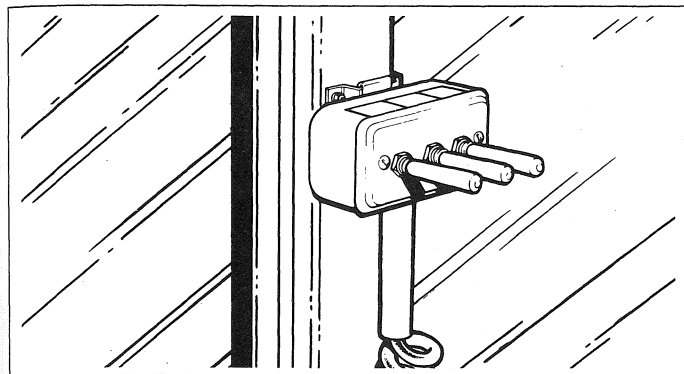

 <p>HEATER</p>	 <p>FRONT DEFROSTER FAN</p>  <p>REAR DEFROSTER FAN</p>	 <p>BRAKE FAILURE</p>	 <p>HORN</p>	 <p>ENGINE WARNING</p>
 <p>TRANSMISSION OIL PRESSURE</p>	 <p>ETHER COLD START</p>	 <p>ENGINE COOLANT TEMPERATURE</p>	 <p>ENGINE OIL PRESSURE</p>	 <p>VOLTS</p>
 <p>FUEL LEVEL</p>	 <p>SUPPLEMENTAL STEERING</p>	 <p>HAND BRAKE</p>	 <p>TRANSMISSION OIL TEMPERATURE</p>	 <p>LOCK/UNLOCK DIFFERENTIAL</p>
 <p>FRONT MAST OPERATION</p>	 <p>WING TILT</p>	 <p>REAR MAST OPERATION</p>	 <p>RIPPER OPERATION</p>	 <p>WINDROW ELIMINATOR</p>



**Pedals and Dimmer Switch**



**Attachment Controls Switch Box for Snow Wing, Ripper or Windrow Eliminator**

-  ENGINE WARNING LIGHT
-  SUPPLEMENTAL STEERING WARNING LIGHT
-  BRAKE WARNING LIGHT
-  HAND BRAKE WARNING LIGHT
-  LOCK/UNLOCK DIFFERENTIAL LIGHT
-  LOCK/UNLOCK DIFFERENTIAL SWITCH
-  ACCESSORY SWITCH
-  ACCESSORY SWITCH

The Switches and Warning Lights are located on the right-hand door post. Positions of switches and warning lights are optional.

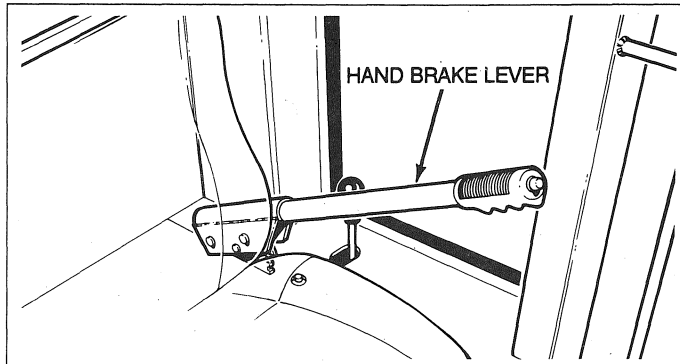

The Hand Brake Lever is located on the left-hand side of the cab.

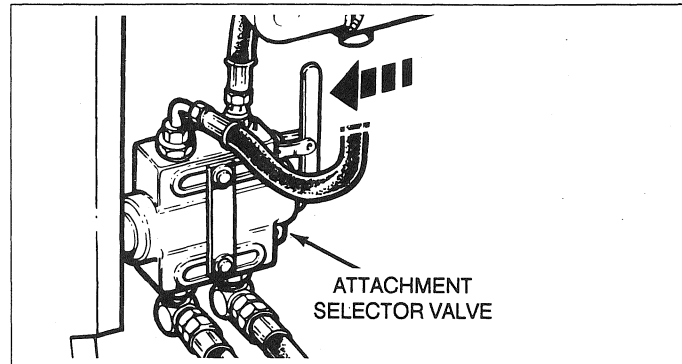

The Attachment Selector Valve is located on the left-hand side of the frame, behind the nose plate.

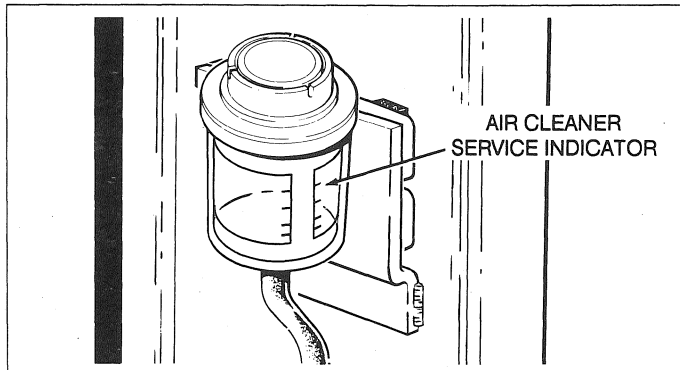

Air Cleaner Service Indicator - Left-hand Door Post

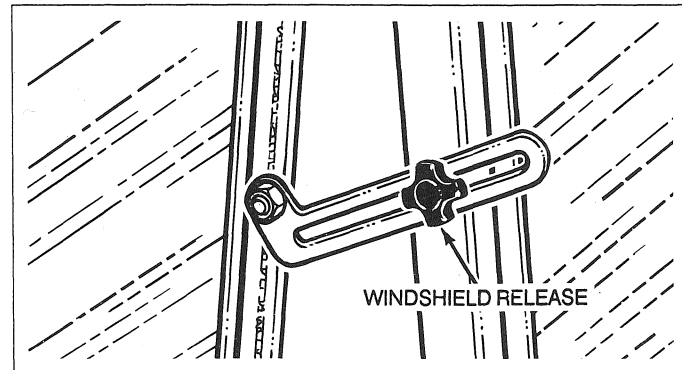

Windshield Release

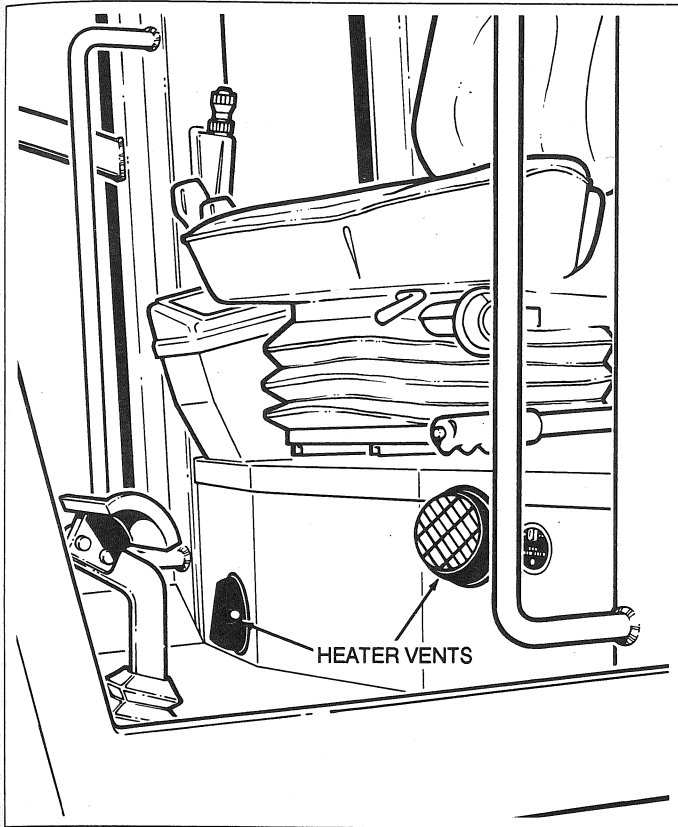

Heater Vents

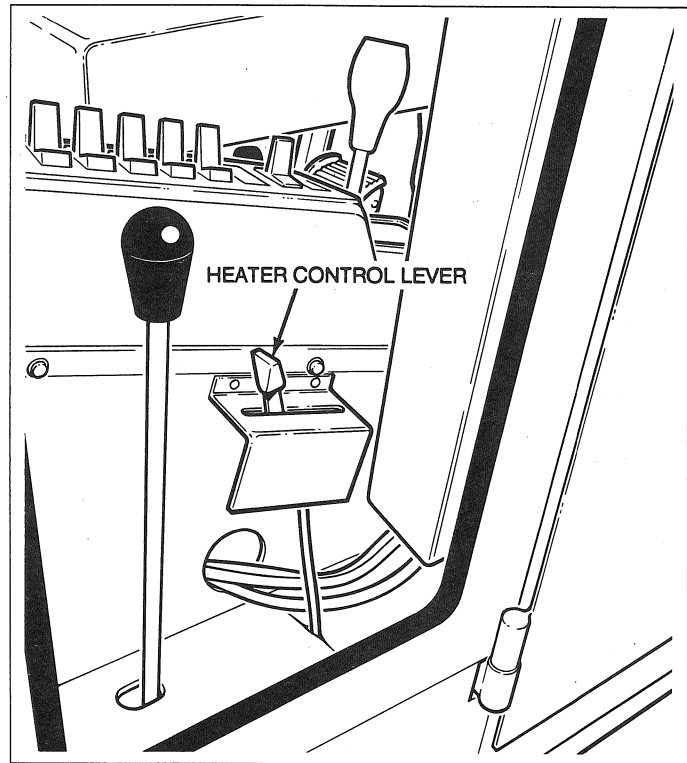

The Heater Control Lever is located on the right-hand side of the cab. Move the lever to increase or decrease the temperature.

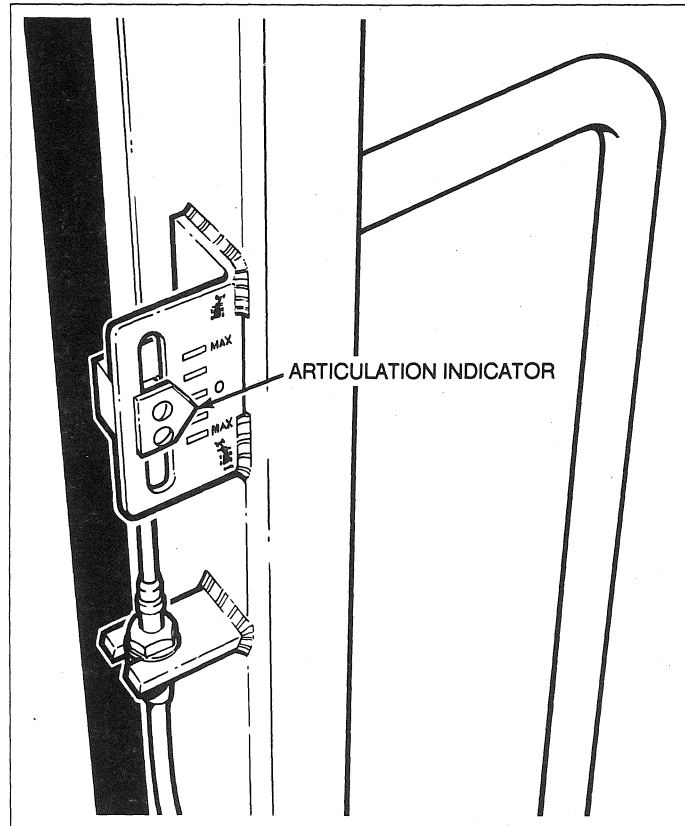

Articulation Indicator (Left-hand side of cab)

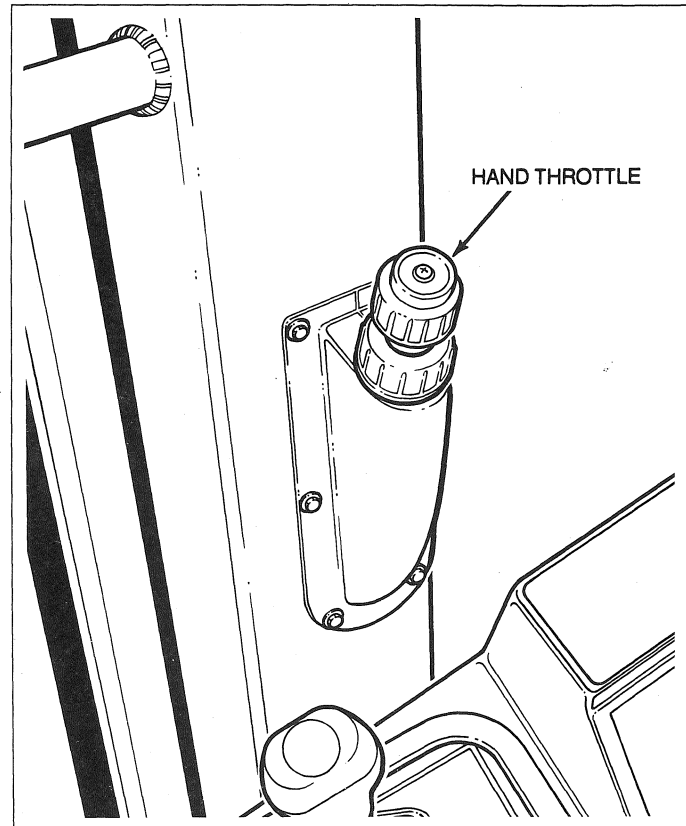

Hand Throttle (Right-hand door post)

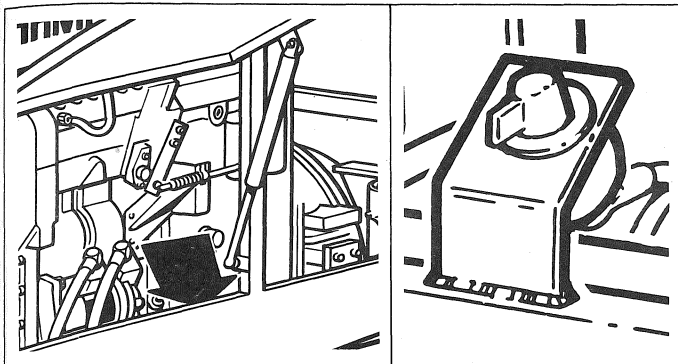

## Battery Isolation Switch(es)

The battery isolation switch(es) is located inside of the engine compartment. Turn the switch(es) to the ON position before starting the grader. At the end of the day, turn the switch(es) to the OFF position for added security.

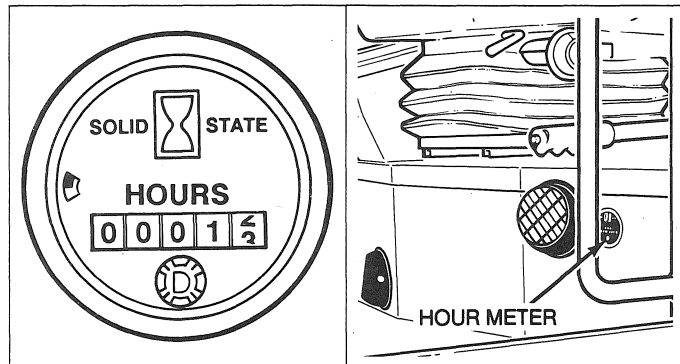

The Hour Meter is located on the left-hand side of the cab, beside the heater vent.



## **⚠ WARNING**

Never short across starter terminals. Grader could move unexpectedly. See Operator's Manual.

Do not bypass the battery isolation switch(es). Have the switch(es) repaired if it is not working properly.

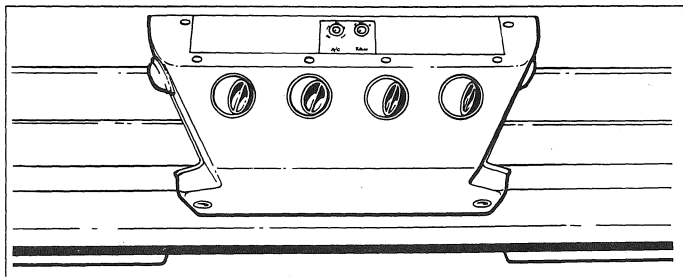

The Air Conditioner is located on the ceiling of the cab. Air vents and controls are located at the front of the air conditioner.

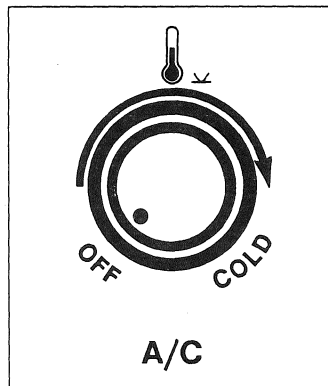

The Thermostat Control adjusts the temperature of the air from a minimum to maximum setting.

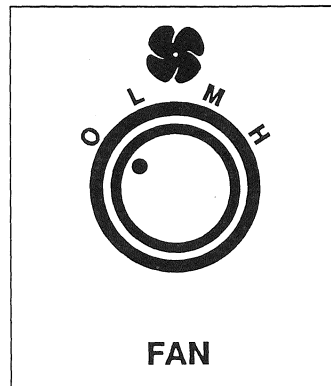

The Fan Speed Control adjusts the air flow speed from off to low, medium, and high.

**NOTE:** The Fan Speed Control and Thermostat Control should be adjusted together. When reducing the air flow, you must reduce the thermostat setting to avoid freezing the evaporator coil.



**Air Conditioner Operation and Radiator Shutters.** When using the air conditioner on graders equipped with a radiator shutter, you must keep the shutter louvers open. This avoids excessive compressor cycling due to a reduced air flow.

### **Radiator Shutter Operation (Manual Override) - Air Conditioner in Use (Summer Operation).**

- Ensure the air conditioner is turned off.
- Allow the engine to reach operating temperature.
- Turn the manual override knob clockwise to keep the shutter open. The shutter louvers remain open after the engine cools.

### **Radiator Shutter Operation (Automatic Control) - Air Conditioner not in Use (Winter).**

- Allow the engine to reach operating temperature.
- Turn the manual override knob counter-clockwise to return the shutter to automatic control. The shutter louvers close automatically when the engine cools.

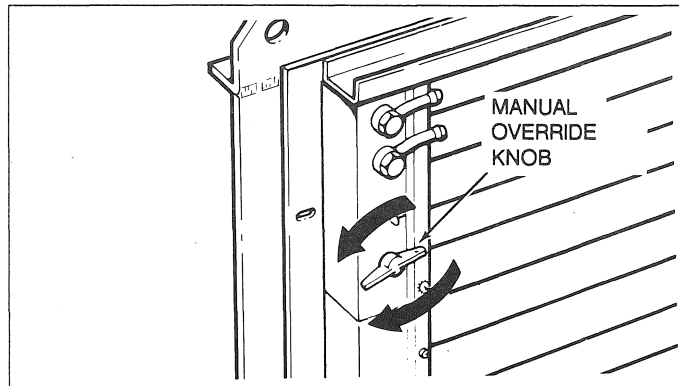

### **⚠ CAUTION**

Do not turn the manual override knob on or off when the engine is cold. Damage to the shutter thermostat will result. Turn the manual override knob only after the engine reaches operating temperature.

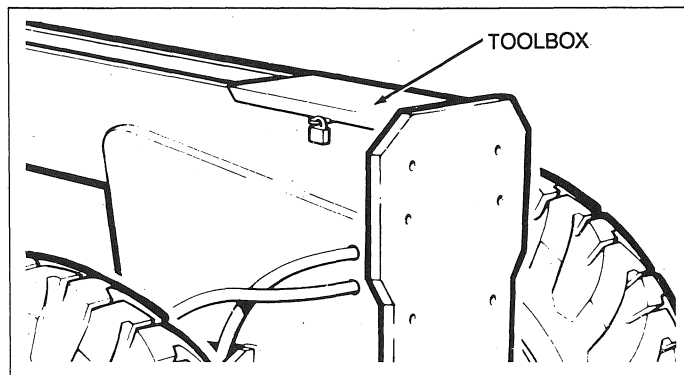
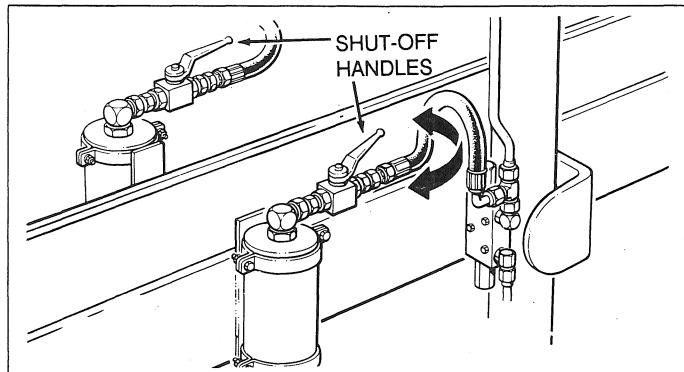

### Circle System Accumulators

Some graders are equipped with blade lift and circle shift accumulators. The accumulators absorb shock loads and protect the circle system from impact damage when the grader is working in arduous applications.

In fine grading operations, where a high degree of blading tolerance is needed, the accumulators can be isolated from the hydraulic system. This is done using shut-off valves. Shut-off valve handles, found in the toolbox located in the front of the grader frame, are supplied for this purpose. Turn the handle clockwise to connect the accumulator with the hydraulic system. Turn the handle counter-clockwise to isolate the accumulator from the hydraulic system.